

New Bookeye®
and WideTEK®
products!

Image Access Scanners

Your Source for
Superior Large Format Scanning



Product Catalog 2022



Wide Format Fine Art Scanner

WideTEK® 36ART.....	4
WideTEK® 36ART Hardware Options.....	5

Wide Format Flatbed Scanners

WideTEK® 12.....	6
New! WideTEK® 12 SPECTRUM.....	7
WideTEK® 25.....	8
New! WideTEK® 24F.....	9

Wide Format Sheetfeed Scanners

WideTEK® 36CL.....	10
WideTEK® 48CL.....	11
WideTEK® 60CL.....	12
WideTEK® CL Bundles.....	13
WideTEK® 36CL-SCREEN-BRIDGE.....	14
WideTEK® 36, 44 and 48 Bundles.....	15
WideTEK® 36.....	16
WideTEK® 36DS.....	17
WideTEK® 44.....	18
WideTEK® 48.....	19

Wide Format MFP Solutions

WideTEK® 36CL MF*.....	20
PrintWizard.....	21
WideTEK® 36CL MF1, 5, 6.....	22
WideTEK® 36CL MF2, 3, 4.....	23
WideTEK® Adjustable Stand.....	24

Book Scanners

Introducing Bookeye® 5.....	25
Bookeye® 5 Features & Functionality.....	26
Bookeye® 5 Three Models.....	27
Bookeye® 5 V3.....	28
Bookeye® 5 V2.....	29
Introducing Bookeye 5 Automatic.....	30
Bookeye® 5 Automatic Two Models... ..	31
Bookeye® 5 V2 Semiautomatic.....	32
New! Bookeye® 5 V1A Professional.....	33
Bookeye® 5 V1A-C35/C50.....	34

Production Software

Scan2Pad®.....	35
Scan2PS.....	36
Batch Scan Wizard.....	37
Scan2OCR.....	38
Scan2ICC.....	38
PerfectStitch.....	39
BCS-2.....	39



WideTEK® 36

Art



- ✓ Contact-free scanning of fragile material or even wet artwork
- ✓ Document thickness of 200 mm / 8 inches (Canvas up to max. 100 mm in a frame up to 200 mm thickness)
- ✓ Large 15" color touchscreen for simple, ergonomic operation and previews
- ✓ Single path 3D like texture scanning, stitching
- ✓ Dual LED lamps with integrated natural light diffusor, no warm up, IR/UV free
- ✓ Scan table can be moved manually or motorized, scans art or other material 914 x 1524 mm / 36 x 60 inches wide
- ✓ Fastest color scanning at 42.2 mm/s / 1.66 inch/s @ 300 dpi
- ✓ Easy installation via Scan2Net® technology

The WideTEK® 36ART was designed for archiving and reproduction of works of art. Originals are moved under the CCD camera elements, protecting the art from damage and making it possible to scan a painting that is still wet, as long as it is framed or dry enough to place on the scanning bed. In cooperation with large format printers from HP, Canon and EPSON, the WideTEK® 36ART provides the basis for professional art reproduction. A scan table extension can be purchased which allows originals up to a length of 2224 mm (87.6 inches) to be scanned.

Scanner Optics	CCD camera, scans in color, grayscale, B&W
Resolution	600 x 600 dpi optical resolution
Document Size	914 x 1524 mm (36 x 60 inches), 914 x 2224 mm (36 x 87.6 inches) with optional scan table extension
Scanning Speed	300 dpi - 42.2 mm/s / 1.66 inch/s in color 300 dpi - 21.1 mm/s / 0.83 inch/s in color, 3D texture
Color Depth	48 bit color, 16 bit grayscale
Scan output	24 bit color, 8 bit grayscale, bitonal, enhanced half-tone
Output Formats	Multipage PDF (PDF/A) and TIFF, JPEG, JPEG 2000, PNM, PNG, BMP, TIFF (Raw, G3, G4, LZW, JPEG), AutoCAD DWF, JBIG, DjVu, DICOM, PCX, Postscript, EPS, Raw data
Size H x W x D & Weight	with runway: 1380 x 3275 x 1280 mm (54.3 x 128.9 x 50.4 inches) without runway: 1380 x 690 x 1280 mm (54.3 x 27.2 x 50.4 inches) Scan table: 1000 x 2100 mm (39.4 x 82.7 inches) 200 kg (440 lbs.) Scan table: 22,5 kg (50 lbs.)
Quality (min.)	ISO 19264-1 level B, FADGI ***, Metamorfoze
Power Consumption	< 0.5 W (Sleep) / 5.2 W (Standby) / < 50 W (Ready to scan) / < 110 W (Scanning)

WideTEK 36ART Backlight Option

The WideTEK® 36ART brings an even higher return on investment with the addition of the backlight option for scanning transparent material of all kinds, like stained glass, glass negatives, cutout stencils, sepias and much more. Even transparent fabrics and flat objects can be digitized and with very little effort, extracted from the background.

By installing the optional WideTEK® 36ART backlight module, users can scan with or without backlight, depending on the source material requirements, by simply switching the light on or off.



Stained glass church windows scanned on a WideTEK 36ART with backlight option

Competing large format scanners on the market that have a backlight option are very rare and/or prohibitively expensive. The WideTEK 36ART goes far beyond just standard scanning and does it at a surprisingly affordable price.

The WideTEK 36ART is also ideal for photographers, galleries, advertising agencies and graphic artists to present and preserve their work in a digital format. Even industrial applications are part of the WideTEK 36ART's installation base... just be creative!

WideTEK® 36

Hardware Options

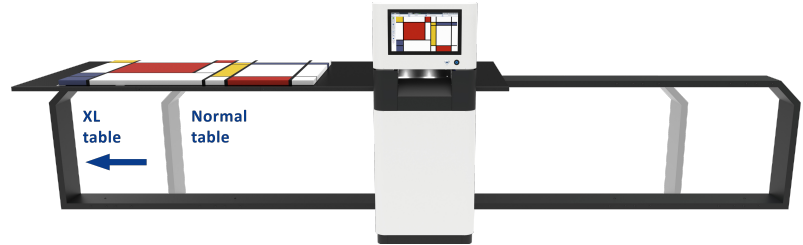

WideTEK 36ART Extension Kit

The standard scanning area on the WideTEK 36ART is 36 x 60 inches. Upgrading the scanner with the WideTEK 36ART Extension Kit increases the scanning area by additional 70 cm (27.6") to a total length of more than two meters (2224 mm / 87.6").

The Extension Kit is an optional add on which can easily be retrofitted to any existing WideTEK 36ART installation.

WideTEK® 12



- ✓ Fits on any desktop: 79 cm / 31 inch depth, slightly more than the scanning area but scans 18% more surface area than A3.
- ✓ Captures 3D surfaces for industrial quality inspection: fabric weaves, patterns and textures, Braille print, etc.
- ✓ Optional backlight unit for transparencies, films, photos, X-rays
- ✓ Two LED lamps with diffusors, no warm up, IR/UV free
- ✓ 7" built-in 1280*800 color multitouch screen, optional 21" full HD touchscreen
- ✓ Scan2USB for walk up scanning to USB 3.0, Scan2Print for output to any connected printer, Scan2Network for output to any network drive, Scan2FTP, Scan2Mail
- ✓ Automatic crop & deskew, on the fly rotation of images
- ✓ Real time display & modification of images without having to rescan
- ✓ Easy installation via Scan2Net® technology

The WideTEK® 12 flatbed scanner has all the features and high scanning speed of the WideTEK 25 in a smaller A3+ model at a highly competitive price. WideTEK 12 scans the full bed (18% more than A3, 313 x 470 mm / 12.3 x 18.5 inch) at 300 dpi color in less than 3 seconds, twice as fast as the closest competition. The revolutionary 3D scanning mode opens new opportunities in printing and industrial inspection markets. The new scratch resistant, non-reflective glass plate has been extended to reach the edges of the scanner, making it 100% protective of the documents laid on it.

Scanner Optics	CCD camera, scans in color, grayscale, B&W
Resolution	1200 x 1200 dpi scanner resolution 1200 x 600 dpi optical resolution
Document Size	313 x 470mm (12.3 x 18.5 inches)
Fastest Speed	300 dpi, full bed < 3 sec in color 300 dpi, full bed < 6 sec in 3D texture mode
Color Depth	48 bit color, 16 bit grayscale
Scan output	24 bit color, 8 bit grayscale, bitonal, enhanced half-tone
Output Formats	Multipage PDF (PDF/A) and TIFF, JPEG, JPEG 2000, PNM, PNG, BMP, TIFF (Raw, G3, G4, LZW, JPEG), AutoCAD DWF, JBIG, DjVu, DICOM, PCX, Postscript, EPS, Raw data
Size H x W x D & Weight	222 x 440 x 795 mm (8.7 x 17.4 x 31.3 inches) 28 kg (62 lbs.)
Quality (min.)	ISO 19264-1 level A, FADGI ****, Metamorforze
Power Consumption	< 0.5 W (Sleep) / 2.5 W (Standby) / 28 W (Ready to scan) / 55 W (Scanning)

The WideTEK® 12-Spectrum is the world's fastest UV, VIS, IR, 3D and backlight flatbed scanner for formats up to DIN A3+ (12" x 18"). Applications include authenticity verification of banknotes, passports, ID cards, certificates and other special objects containing security features. The scanner captures fluorescence from UV active ink and other objects at 365nm UV light and scans the IR contrast of documents at 850nm IR light. Scanning with visible light also allows digitization in 3D to capture textures of surfaces like braille, fabrics, wood, artwork and many other objects. The built-in backlight in the lid detects watermarks and other semi-transparent features of documents.

Scanner Optics	CCD camera, scans in color, grayscale, B&W
Resolution	1200 x 1200 dpi scanner resolution 1200 x 600 dpi optical resolution
Document Size	313 x 470mm (12.3 x 18.5 inches)
Scan Speed (in color)	Maximum format VIS & IR @ 300 dpi < 3 s, @ 600 dpi < 6 s, @ 1200 dpi < 12; UV @ 300 dpi 12 s
Color Depth	48 bit color, 16 bit grayscale
Scan output	24 bit color, 8 bit grayscale, bitonal, enhanced half-tone
Output Formats	Multipage PDF (PDF/A) and TIFF, JPEG, JPEG 2000, PNM, PNG, BMP, TIFF (Raw, G3, G4, LZW, JPEG), AutoCAD DWF, JBIG, DjVu, DICOM, PCX, Postscript, EPS, Raw data
Size H x W x D & Weight	255 x 440 x 795 mm (10 x 17.4 x 31.3 inches) 30 kg (66 lbs.)
Quality (min.)	ISO 19264-1 level A, FADGI ****, Metamorforze
Power Consumption	< 0.5 W (Sleep) / 2.5 W (Standby) / 28 W (Ready to scan) / 55 W (Scanning) / 150 W (Backlight)

WideTEK® 12

SPECTRUM



- ✓ Includes all of the basic features of the WideTEK 12, plus...
- ✓ All in one multiwavelength, multilight scenario scanner
- ✓ Scans with UV (365nm) excited fluorescence of ink and other objects to prove authenticity.
- ✓ Scans the IR (850nm) reflectivity of surfaces to prove authenticity
- ✓ Scans in visible light (VIS) with highest geometric and color accuracy for all types of quality control applications
- ✓ Scans 3D in visible light (VIS) to capture surface properties of fabrics, wood, tiles, artwork etc. with highest precision
- ✓ Scans semi-transparent objects with the backlight unit to capture watermarks, transparencies, and many other objects
- ✓ Scanner is significantly faster and captures larger scan areas than many expensive lab instruments for a fraction of their cost

WideTEK® 25



- ✓ Fits on any desktop: 31 inch depth, only 6 inches more than the scanning area.
- ✓ Captures 3D surfaces for industrial quality inspection: material weaves, patterns and textures, Braille print, etc.
- ✓ Optional backlight unit for transparencies, films, photos, X-rays
- ✓ Two LED lamps with diffusers, no warm up, IR/UV free
- ✓ 7" built-in 1280*800 color multitouch screen, optional 21" full HD touchscreen
- ✓ Scan2USB for walk up scanning to USB 3.0, Scan2Print for output to any connected printer, Scan2Network for output to network drives, Scan2FTP, Scan2Mail
- ✓ Automatic crop & deskew, on the fly rotation of images
- ✓ Real time display & modification of images without having to rescan
- ✓ Easy installation via Scan2Net® technology

The WideTEK® 25 flatbed scans the full bed (A2+, 635 x 470mm, 18½ x 25 inch) at 300 dpi color in less than three seconds - two times faster than the closest competition. Scan transparent material of all kinds with the WT25-BACKLIGHT option, such as X-rays, glass negatives, 35 mm microfilm aperture cards, sepias, cutout stencils and film. The revolutionary 3D scanning mode enables new applications in the printing and industrial inspection markets. The new scratch resistant, non-reflective glass plate has been expanded to reach the edges of the scanner, making it 100% protective of the documents laid on it.

Scanner Optics	CCD camera, scans in color, grayscale, B&W
Resolution	1200 x 1200 dpi scanner resolution 1200 x 600 dpi optical resolution
Document Size	635 x 470mm (25 x 18.5 inches)
Fastest Speed	300 dpi, full bed < 3 sec in color 300 dpi, full bed < 6 sec in 3D texture mode
Color Depth	48 bit color, 16 bit grayscale
Scan output	24 bit color, 8 bit grayscale, bitonal, enhanced half-tone
Output Formats	Multipage PDF (PDF/A) and TIFF, JPEG, JPEG 2000, PNM, PNG, BMP, TIFF (Raw, G3, G4, LZW, JPEG), AutoCAD DWF, JBIG, DjVu, DICOM, PCX, Postscript, EPS, Raw data
Size H x W x D & Weight	225 x 760 x 795 mm (8.9 x 29.9 x 31.3 inches) 45 kg (100 lbs.)
Quality (min.)	ISO 19264-1 level A, FADGI ****, Metamorforze
Power Consumption	< 0.5 W (Sleep) / 4,8W (Standby) / 35 W (Ready to scan) / 72 W (Scanning)

WideTEK® 24F is the newest large format flatbed scanner. Incorporating the latest camera technology and illumination, it is not only extremely fast but also scans highly accurately at resolutions up to 1200 dpi but is still an affordable solution. By far the fastest CIS flatbed scanner on the market, WideTEK 24F completes a full 600dpi color scan of the entire area in less than 4 seconds. During those few seconds, the image is compressed and sent over the network, all while the competitor's product is still working on its 200dpi scan. The 1200dpi resolution provides details of the scanned document not even visible to the human eye.

Scanner Optics	CIS camera, scans in color, grayscale, B&W
Resolution	1200 x 1200 dpi scanner resolution 1200 x 600 dpi optical resolution
Document Size	610 x 457mm (24 x 18 inches)
Fastest Speed	300 dpi, full bed < 4 sec 1200 dpi, full bed < 8 sec
Color Depth	48 bit color, 16 bit grayscale (internal resolution)
Scan output	24 bit color, 8 bit grayscale, bitonal, enhanced half-tone
Output Formats	Multipage PDF (PDF/A) and TIFF, JPEG, JPEG 2000, PNM, PNG, BMP, TIFF (Raw, G3, G4, LZW, JPEG), AutoCAD DWF, JBIG, DjVu, DICOM, PCX, Postscript, EPS, Raw data and more
Size H x W x D & Weight	140 x 730 x 900 mm (5.5 x 29 x 36 inches) 28 kg (62 lbs.)
Quality (min.)	ISO 19264-1 level B, FADGI ***, Metamorfoze Light
Power Consumption	< 0.5 W (Sleep) / 2.5 W (Standby) / 35 W (Ready to scan) / 70 W (Scanning)

WideTEK® 24F



- ✓ Borderless, fully scratch-resistant glass plate prevents bent edges on source documents and allows scanning oversized documents.
- ✓ Removable and height-adjustable lid to accommodate thicker and irregularly shaped objects like magazines, canvases, etc.
- ✓ Depth of focus five times more than the closest competitor
- ✓ Fastest CIS Flatbed, 3,5 sec. @600 dpi
- ✓ 7" built-in 1280*800 color multitouch screen, optional 21" full HD touchscreen
- ✓ Scan2USB for walk up scanning to USB 3.0, Scan2Print for output to any connected printer, Scan2Network for output to any network drive, Scan2FTP, Scan2Mail
- ✓ Automatic crop & deskew, on the fly rotation of images
- ✓ Real time display & modification of images without having to rescan
- ✓ Easy installation via Scan2Net® technology

WideTEK® 36CL



- ✓ Face up scanning with on the fly rotation and modification of images without rescanning. Automated crop & deskew.
- ✓ LED lamps, no warm up, IR/UV free
- ✓ 7" built-in 1280*800 color multitouch screen, optional 21" full HD touchscreen
- ✓ Scan2USB for walk up scanning to USB 3.0, Scan2Print for output to any connected printer, Scan2Network for output to any network drive, Scan2FTP, Scan2Mail
- ✓ Touchscreen enhanced versions of ScanWizard, PrintWizard and EasyScan
- ✓ LED illumination, sturdy steel document scanning bed
- ✓ Fastest scan in color: 10 inches/second at 200 dpi, full width
- ✓ Easy installation via Scan2Net® technology

The WideTEK® 36CL is by far the fastest color CIS scanner on the market, running at 10 inches per second at 200 dpi in full color and a true standalone system at the lowest possible price. At the full width of 36" and 600 dpi resolution, the scanner still runs at 1.7 inches per second. Grayscale and binary speeds are doubled, but the speed can be limited to scan fragile, valuable documents. WideTEK® 36CL is capable of scanning directly to FTP servers, hot folders, USB drives via a USB 3.0 port, to cloud applications in the Internet or copying to printers directly, without the need for an extra PC.

Scanner Optics	CIS camera, scans in color, grayscale, B&W
Resolution	1200 x 1200 dpi scanner resolution 9600 x 9600 dpi interpolated (optional)
Document Size	965 mm (38 inch) width, nearly unlimited length Scans 915 mm (36 inch) widths
Scanning Speed	200 dpi - 15 m/min (10 inch/s) in color 600 dpi - 8 m/min (5 inch/s) in grayscale
Color Depth	48 bit color, 16 bit grayscale
Scan output	24 bit color, 8 bit grayscale, bitonal, enhanced half-tone
Output Formats	Multipage PDF (PDF/A) and TIFF, JPEG, JPEG 2000, PNM, PNG, BMP, TIFF (Raw, G3, G4, LZW, JPEG), AutoCAD DWF, JBIG, DjVu, DICOM, PCX, Postscript, EPS, Raw data
Size H x W x D & Weight	170 x 1088 x 358 mm (6.7 x 42.8 x 14.1 inches) 24 kg (53 lbs.)
Quality (min.)	ISO 19264-1 level B, FADGI ***
Power Consumption	< 0.5 W (Sleep) / 5.2 W (Standby) / < 25 W (Ready to scan) / < 45 W (Scanning)

WideTEK® 48CL

The WideTEK® 48CL is by far the fastest 48 inch color CIS scanner on the market, producing production quality images at 10 inches per second for 150 dpi in full color. At the full width of 48" and 1200 dpi resolution, the scanner still runs at 0.83 inches per second. The scanning speeds are tripled in black and white and greyscale modes but the speed can be limited if required to scan fragile, valuable documents. The WideTEK® 48CL has what it takes to run in a production environment 24/7, while still being among the lowest priced scanners of its size on the market.



Scanner Optics	CIS camera, scans in color, grayscale, B&W
Resolution	1200 x 1200 dpi scanner resolution 9600 x 9600 dpi interpolated (optional)
Document Size	1270 mm (50 inch) width, more than 65 m (200 ft) max. scan length Scans 1220 mm (48 inch) widths
Scanning Speed	200 dpi - 11.4 m/min (7.5 inch/s) in color 600 dpi - 5.8 m/min (3.8 inch/s) in grayscale
Color Depth	48 bit color, 16 bit grayscale
Scan output	24 bit color, 8 bit grayscale, bitonal, enhanced half-tone
Output Formats	Multipage PDF (PDF/A) and TIFF, JPEG, JPEG 2000, PNM, PNG, BMP, TIFF (Raw, G3, G4, LZW, JPEG), AutoCAD DWF, JBIG, DjVu, DICOM, PCX, Postscript, EPS, Raw data
Size H x W x D & Weight	170 x 1418 x 358 mm (6.7 x 55.8 x 14.1 inches) 28.5 kg (63 lbs.)
Quality (min.)	ISO 19264-1 level B, FADGI ***
Power Consumption	< 0.5 W (Sleep) / 5.2 W (Standby) / <25 W (Ready to scan) / <45 W (Scanning)

- ✓ Face up scanning with on the fly rotation and modification of images without rescanning. Automated crop & deskew.
- ✓ LED lamps, no warm up, IR/UV free
- ✓ Real time display of images and modification without rescanning
- ✓ Scan2USB for walk up scanning to USB 3.0, Scan2Print for output to any connected printer, Scan2Network for output to any network drive, Scan2FTP, Scan2Mail
- ✓ Touchscreen enhanced versions of ScanWizard, PrintWizard and EasyScan
- ✓ LED illumination, sturdy steel document scanning bed
- ✓ 7" built-in 1280*800 color multitouch screen, optional 21" full HD touchscreen for easier operation in optional bundles
- ✓ Fastest scan at 200 dpi in color: 11.4 m/min (7.5 inch/sec)
- ✓ Easy installation via Scan2Net® technology

WideTEK® 60CL



- ✓ Face up scanning, on the fly rotation and modification of images without rescanning. Automated crop & deskew
- ✓ Thick media support up to 12 mm (0.5 inches)
- ✓ 7" built-in 1280*800 color multitouch screen, optional 21" full HD touchscreen, floor stand and paper catch included
- ✓ Scan2USB for walk up scanning to USB 3.0, Scan2Print for output to any connected printer, Scan2Network for output to any network drive, Scan2FTP, Scan2Mail
- ✓ Touchscreen enhanced versions of ScanWizard, PrintWizard and EasyScan
- ✓ LED illumination, sturdy steel document scanning bed
- ✓ Fastest scan in color: 6 inches/second at 200 dpi, full width
- ✓ Easy installation via Scan2Net® technology

The WideTEK® 60CL-600 is by far the fastest 60 inch color CIS scanner on the market, producing production quality images at 8 inches per second for 150 dpi in full color. At the full width of 60" and 600 dpi resolution, the scanner still runs at 1 inch per second.

Through reengineering and utilizing the most advanced CIS modules, the WideTEK® 60CL scans documents up to 61,85 inches wide with a maximum scanning width of 60 inches, producing extraordinarily sharp images at remarkable speeds, with color accuracy even superior to competing CCD scanners. The WideTEK® 60CL exceeds FADGI *** guidelines and complies with the ISO 19264-1 standard.

Scanner Optics	CIS camera, scans in color, grayscale, B&W
Resolution	1200 x 1200 dpi scanner resolution 9600 x 9600 dpi interpolated (optional)
Document Size	1570 mm (61.85 inch) width, nearly unlimited length Scans 1524 mm (60 inch) widths
Scanning Speed	200 dpi - 9.1 m/min (6 inch/s) in color 600 dpi - 1.5 m/min (1 inch/s) in color
Color Depth	48 bit color, 16 bit grayscale
Scan output	24 bit color, 8 bit grayscale, bitonal, enhanced half-tone
Output Formats	Multipage PDF (PDF/A) and TIFF, JPEG, JPEG 2000, PNM, PNG, BMP, TIFF (Raw, G3, G4, LZW, JPEG), AutoCAD DWF, JBIG, DjVu, DICOM, PCX, Postscript, EPS, Raw data
Size H x W x D & Weight	170 x 1697 x 358 mm (6.7 x 66.8 x 14.1 inches) 34 kg (75 lbs.)
Quality (min.)	ISO 19264-1 level B, FADGI ***
Power Consumption	< 0.5 W (Sleep) / < 5.8 W (Standby) / < 30 W (Ready to scan) / < 50 W (Scanning)

WideTEK® CL Bundles

The WideTEK® CL scanner bundles offer maximum value at a very attractive price. All bundles include two years Limited Warranty plus one year Full Coverage Warranty, the most complete warranty in the industry. Each bundle is targeted for a special application but can also be upgraded to another bundle with the purchase of a few options. All bundles include software and a built in PC, no external equipment required.

For conversion projects
WideTEK 36CL-600-BDL1
WideTEK 48CL-600-BDL1



This scanner bundle was designed for conversion projects which require extensive scanning, automatic file naming, indexing and batch scanning capabilities. It includes an ergonomic floorstand and an adjustable paper catch. This configuration is intended to be used with external software like our Batch Scan Wizard which is included in the bundle.

A walk up scanning solution
WideTEK 36CL-600-BDL2
WideTEK 48CL-600-BDL2



This bundle is the perfect walk up scanning solution for self-service applications in any location. In addition to the features of the BDL1 bundle, it comes with a full HD 22" touchscreen attached to the floor stand via a user adjustable monitor arm. Operation and full display of the scans make this configuration the preferred choice for walk up applications.

A multifunction copier/printer
WideTEK 36CL-600-MFP
WideTEK 48CL-600-MFP



If copying directly to wide format printers is your main application but you still want to be able to use the scanner for walk up and larger scanning jobs, the MFP bundle is the right choice. Since the printer connection is via Gigabit network, printers can be kept separate and the user can enjoy the ergonomics of a free standing scanner, even in a different room.

WideTEK® 36CL-Screen-Bridge

The WT36/48CL-SCREEN-BRIDGE allows positioning a full HD 21" touchscreen on top of any WideTEK 36CL or 48CL scanner. The monitor bridge is mounted to the sides of the scanner and spans across the top, leaving enough space for documents to be returned to the front. Due to the unique mounting method, the bridge does not require any additional footprint.

The monitor included features 16:9 full HD (1920 x 1080) resolution and a 3,000:1 high contrast ratio. Combined with a wide (178°/178°) viewing angle, it is ideally suited for effective job handling including high resolution previews.

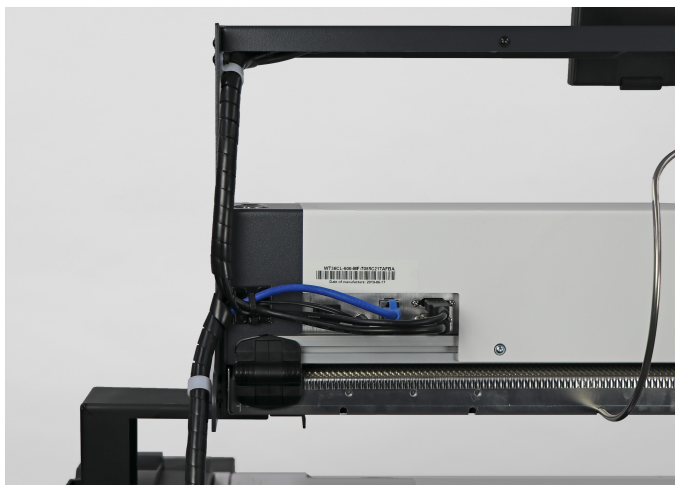

Rear view of intelligent connector and cable guides



- ✓ Runs the ScanWizard scanner control software on a modern multi-touch full HD screen with 1920 x 1080 pixels
- ✓ Zoom and pan scanned images in real time like on a smartphone
- ✓ Paper path and scanner service position are not obstructed
- ✓ A variety of mounting options for many different screen positions
- ✓ Assembly time is less than 20 minutes, only one tool required
- ✓ Intelligent cable handling routes all cables neatly to the back
- ✓ Two versions, for WideTEK 36CL and WideTEK 48CL scanners
- ✓ Power consumption only 20VA (typical), ENERGYSTAR compliant

WideTEK® 36/44/48 Bundles

Pick a solution that features the **world's best large format MFP scanners**, fast enough to keep up with your printer, at lowest retail prices

The WideTEK® CCD scanner bundles offer maximum value at a very attractive price. All bundles include two years Limited Warranty plus one year Full Coverage Warranty, the most complete warranty in the industry. Each bundle is targeted for a special application but can also be upgraded to another bundle with the purchase of a few options. All bundles include software and a built in PC, no external equipment required.

For conversion projects

WideTEK 36-600-BDL

WideTEK 44-600-BDL

WideTEK 48-600-BDL



This bundle was designed for conversion projects which require extensive scanning, automatic file naming, indexing and batch scanning. It includes an ergonomic floorstand with a full HD 22" touchscreen attached and an adjustable paper catch. This configuration is intended to be used with external software like our Batch Scan Wizard which is included in the bundle.

An MFP solution

WideTEK 36-600-MFP

WideTEK 44-600-MFP

WideTEK 48-600-MFP



If copying directly to wide format printers is your main application but you still want to be able to use the scanner for walk up and larger scanning jobs, the MFP bundle is the right choice. Since the printer connection is via Gigabit network, printers can be kept separate and the user can enjoy the ergonomics of a free standing scanner, even in a different room.

An MFP solution with Stand

WideTEK 36-600-MFP-ADJ

WideTEK 44-600-MFP-ADJ

WideTEK 48-600-MFP-ADJ



By adding an Adjustable Stand to the bundle, you have the additional benefit of a universal multifunction stand, the most versatile and sturdy MFP stand in the industry. It supports nearly all large format printers on the market up to 1016 mm (40 inches) high and 1473 mm (58 inches) wide. A large table for an external monitor is included.

WideTEK® 36



- ✓ Face up scanning with on the fly rotation and modification of images without rescanning. Automated crop & deskew.
- ✓ Scans 36 inch widths, feeds 37.4 inch widths, nearly unlimited lengths (scans in „endless mode“)
- ✓ Real time display of images and modification, no rescanning
- ✓ Fastest color scanning at 200 dpi, 15 inches per second
- ✓ Touchscreen enhanced versions of ScanWizard, PrintWizard and EasyScan
- ✓ Scan2USB for walk up scanning to USB 3.0, Scan2Print for output to any connected printer, Scan2Network for output to network drives, Scan2FTP, Scan2Mail
- ✓ 7“ built-in 1280*800 color multitouch screen, optional 21“ full HD touchscreen for simplified operation
- ✓ Easy installation via Scan2Net® technology

WideTEK® 36 scans documents up to 36 inches wide (915 mm). State of the art illumination using bright white LEDs guarantees long lifetime and allow low cost of ownership, since there are practically no consumables necessary over the life of the product. Cutting edge camera technology and a dust-protected, fully sealed camera box holding CCD systems which use a patented stitching procedure, delivers a resolution of up to 1200 dpi optical. A recently developed user exchangeable black or white background drum never touches the glass plate.

Scanner Optics	CCD camera, scans in color, grayscale, B&W
Resolution	1200 x 1200 dpi scanner resolution 1200 x 600 dpi optical resolution 9600 x 9600 dpi interpolated (optional)
Document Size	950 mm (37.4 inch) width feed, nearly unlimited lengths in „endless mode“. Scans 915 mm (36 inch) widths
Scanning Speed	200 dpi - 22.9 m/min (15 inch/s) 600 dpi - 6 m/min (4 inch/s)
Color Depth	48 bit color, 16 bit grayscale
Scan output	24 bit color, 8 bit grayscale, bitonal, enhanced half-tone
Output Formats	Multipage PDF (PDF/A) and TIFF, JPEG, JPEG 2000, PNM, PNG, BMP, TIFF (Raw, G3, G4, LZW, JPEG), AutoCAD DWF, JBIG, DjVu, DICOM, PCX, Postscript, EPS, Raw data and more
Size H x W x D & Weight	228 x 1095 x 507 mm (9 x 43.1 x 20 inches) 41 kg (90 lbs.)
Quality (min.)	ISO 19264-1 level B, FADGI ***
Power Consumption	< 0.5 W (Sleep) / 5.2 W (Standby) / 50 W (Ready to scan) / < 95 W (Scanning)

WideTEK® 36DS

The WideTEK® 36DS is the world's first and only wide format duplex scanner for digitizing double sided printed documents up to 36 inches (915 mm) wide. At 300 dpi optical resolution, the scanner needs only 2.5 seconds to scan the front and back of a newspaper, creating images of four pages in a single pass through the scanner. The scanner has two camera boxes, each holding three CCD systems. After scanning, software separates the scan into four single images; capturing the left and right half of the front and back of the newspaper - everything in one single step.



Scanner Optics	CCD camera, scans in color, grayscale, B&W
Resolution	1200 x 1200 dpi scanner resolution 1200 x 600 dpi optical resolution 9600 x 9600 dpi interpolated (optional)
Document Size	970 mm (38.2 inch) width feed, nearly unlimited length. Scans 915 mm (36 inch) widths
Scanning Speed	200 dpi - 22.9 m/min (15 inch/s) 600 dpi - 6 m/min (4 inch/s)
Color Depth	48 bit color, 16 bit grayscale
Scan output	24 bit color, 8 bit grayscale, bitonal, enhanced halftone
Output Formats	Multipage PDF (PDF/A) and TIFF, JPEG, JPEG 2000, PNM, PNG, BMP, TIFF (Raw, G3, G4, LZW, JPEG), AutoCAD DWF, JBIG, DjVu, DICOM, PCX, Postscript, EPS, Raw data
Size H x W x D & Weight	248 x 1094 x 685 mm (9.8 x 43 x 27 inch) 64 kg (141 lbs.)
Quality (min.)	ISO 19264-1 level B, FADGI ***, Metamorfoze
Power Consumption	< 0.5 W (Sleep) / 10.4 W (Standby) / 100 W (Ready to scan) / 190 W (Scanning)

- ✓ Scans double sided documents up to 36 inches wide in a single pass, 1200 x 1200 dpi scanner resolution
- ✓ 2.5 seconds at 300 dpi for front and back of a newspaper, creating images of four pages in a single pass
- ✓ Twice the scanning power for volume applications
- ✓ Software splits double sided scans into 4 images
- ✓ Fastest color scanning, 15 inches per second
- ✓ LED lamps, no warm up, IR/UV free
- ✓ Scan2USB for walk up scanning to USB, Scan2Print for output to any connected printer, Scan2Network for output to any network drive, Scan2FTP, Scan2Mail, one USB port
- ✓ Easy installation via Scan2Net® technology

WideTEK® 44



- ✓ Face up scanning with on the fly rotation and modification of images without rescanning. Automated crop & deskew.
- ✓ For high resolution scans up to 44 inches (1118 mm) in width, 1200 x 1200 dpi scanner resolution
- ✓ Real time display of images and modification, no rescanning
- ✓ Fastest color scanning, 11.2 inches per second at 200 dpi
- ✓ Touchscreen enhanced versions of ScanWizard, PrintWizard and EasyScan
- ✓ Scan2USB for walk up scanning to USB 3.0, Scan2Print for output to any connected printer, Scan2Network for output to any network drive, Scan2FTP, Scan2Mail
- ✓ 7" built-in 1280*800 color multitouch screen, optional 21" full HD touchscreen for simplified operation in optional bundles
- ✓ Standalone device with its own integrated computer
- ✓ Easy installation via Scan2Net® technology

The WideTEK® 44 CCD scanner scans documents up to 44 inches wide (1118 mm) astonishingly fast and is easily upgradable to a 48 inch scanner. Bright white LED illumination ensures long lifetime and best scan results. WideTEK 44 gently scans due to special transport rollers that serve as pressure points for safe document transport. The new background drum protects the glass plate from scratches and stops document skew. For extra contrast on sepias and film based documents, the black drum can easily be exchanged with a white drum, with no tools required.

Scanner Optics	CCD camera, scans in color, grayscale, B&W
Resolution	1200 x 1200 dpi scanner resolution 1200 x 600 dpi optical resolution 9600 x 9600 dpi interpolated (optional)
Document Size	1270 mm (50 inch width), nearly unlimited length in „endless mode“. Scans 1118 mm (44 inch) widths.
Scanning Speed	200 dpi - 17 m/min (11.2 inch/s) 600 dpi - 4,6 m/min (3 inch/s)
Color Depth	48 bit color, 16 bit grayscale
Scan output	24 bit color, 8 bit grayscale, bitonal, enhanced half-tone
Output Formats	Multipage PDF (PDF/A) and TIFF, JPEG, JPEG 2000, PNM, PNG, BMP, TIFF (Raw, G3, G4, LZW, JPEG), AutoCAD DWF, JBIG, DjVu, DICOM, PCX, Postscript, EPS, Raw data and more
Size H x W x D & Weight	228 x 1425 x 507 mm (9 x 56.1 x 20 inch) 53 kg (117 lbs.)
Quality (min.)	ISO 19264-1 level B, FADGI ***
Power Consumption	< 0.5 W (Sleep) / 6.5 W (Standby) / 60 W (Ready to Scan) / < 120 W (Scanning)

WideTEK® 48

The WideTEK® 48 wide format CCD scanner scans up to 48 inch (1220 mm) wide documents astonishingly fast. Bright white LED illumination ensures a long lifetime and best scan results. The WideTEK 48 gently scans due to special transport rollers that serve as pressure points ensuring safe document transport. The new background drum does not touch the glass plate at any time, avoiding scratches and document skews. For extra contrast on sepias and film based documents, the standard black drum can be easily exchanged with a white drum, with no tools required.



Scanner Optics	CCD camera, scans in color, grayscale, B&W
Resolution	1200 x 1200 dpi scanner resolution 1200 x 600 dpi optical resolution 9600 x 9600 dpi interpolated (optional)
Document Size	1270 mm (50 inch width) nearly unlimited length in „endless mode“. Scans 1220 mm (48 inch) widths
Scanning Speed	200 dpi - 17 m/min (11.2 inch/s) 600 dpi - 4,6 m/min (3 inch/s)
Color Depth	48 bit color, 16 bit grayscale
Scan output	24 bit color, 8 bit grayscale, bitonal, enhanced half-tone
Output Formats	Multipage PDF (PDF/A) and TIFF, JPEG, JPEG 2000, PNM, PNG, BMP, TIFF (Raw, G3, G4, LZW, JPEG), AutoCAD DWF, JBIG, DjVu, DICOM, PCX, Postscript, EPS, Raw data and more
Size H x W x D & Weight	228 x 1425 x 507 mm (9 x 56.1 x 20 inch) 53 kg (117 lbs.)
Quality (min.)	ISO 19264-1 level B, FADGI ***
Power Consumption	< 0.5 W (Sleep) / 6.5 W (Standby) / 60 W (Ready to Scan) / < 120 W (Scanning)

- ✓ Face up scanning with on the fly rotation and modification of images without rescanning. Automated crop & deskew.
- ✓ For high resolution scans up to 48 inches (1220 mm) in width, 1200 x 1200 dpi scanner resolution
- ✓ Real time display of images and modification, no rescanning
- ✓ Fastest color scanning, 11.2 inches per second at 200dpi
- ✓ Touchscreen enhanced versions of ScanWizard, PrintWizard and EasyScan
- ✓ Dust-free camera technology, LED illumination, sturdy steel document scanning bed
- ✓ 7" built-in 1280*800 color multitouch screen, optional 21" full HD touchscreen
- ✓ Scan2USB for walk up scanning to USB 3.0, Scan2Print for output to any connected printer, Scan2Network for output to any network drive, Scan2FTP, Scan2Mail

WideTEK® 36CL-MF



- ✓ Face up scanning with on the fly rotation and modification of images without rescanning. Automated crop & deskew.
- ✓ Built in closed loop color calibration function for best possible copies
- ✓ LED lamps, no warm up, IR/UV free
- ✓ Large 21" full HD color touchscreen for simple operation in optional bundles
- ✓ Scan2USB, FTP, SMB and Network. Copies and emails directly. Touchscreen enabled ScanWizard, PrintWizard and Easyscan
- ✓ LED illumination, sturdy steel document scanning bed
- ✓ Fastest scan in color: 10 inches/second at 200 dpi, full width
- ✓ Easy installation via Scan2Net® technology

The WideTEK® 36CL-MF scanner forms the basis of all of the MF solutions and is the fastest, most productive wide format MFP solution on the market, running at 10 inches per second at 200 dpi in full color, at the lowest possible price. At the full width of 36" and 600 dpi resolution, the scanner still runs at 1.7 inches per second. WideTEK® 36CL-MF is the best choice to build a powerful and high quality MFP with either an integrated printer series specific stand, a high stand or a standalone stand. All MFP solutions come with a built in closed loop color calibration function producing the best possible copies on your selected printer and paper combination.

Scanner Optics	CIS camera, scans in color, grayscale, B&W
Resolution	1200 x 1200 dpi scanner resolution 9600 x 9600 dpi interpolated (optional)
Document Size	965 mm (38 inch) width, nearly unlimited length Scans 915 mm (36 inch) widths
Scanning Speed	200 dpi - 15 m/min (10 inch/s) in color 600 dpi - 8 m/min (5 inch/s) in grayscale
Color Depth	48 bit color, 16 bit grayscale
Scan output	24 bit color, 8 bit grayscale, bitonal, enhanced half-tone
Output Formats	Multipage PDF (PDF/A) and TIFF, JPEG, JPEG 2000, PNM, PNG, BMP, TIFF (Raw, G3, G4, LZW, JPEG), AutoCAD DWF, JBIG, DjVu, DICOM, PCX, Postscript, EPS, Raw data
Size H x W x D & Weight	170 x 1088 x 358 mm (6.7 x 42.8 x 14.1 inches) 24 kg (53 lbs.)
Quality (min.)	ISO 19264-1 level B, FADGI ***
Power Consumption	< 0.5 W (Sleep) / 5 W (Standby) / < 25 W (Ready to scan) / < 45 W (Scanning)

Fully Featured Wide Format MFP Solution with No Compromises

PrintWizard converts every WideTEK® scanner to a powerful MFP system by adding the printer of your choice. The PrintWizard is an extension to the ScanWizard and adds print and copy functionality to it. PrintWizard maintains full control of all features of the attached printer, even paper properties or the level of available ink are visible without having to physically access the printer.

Templates

ScanWizard and PrintWizard each have five predefined scanner and printer templates which help the less experienced user to pick the right settings. The settings defined by the templates as well as their names can be changed and new templates can be added to suit other applications.

Copy Button

The copy button is also freely configurable and allows a single button copy function, using any one of the templates. This makes copying a set of large documents a simple task for everyone.

ScanWizard

ScanWizard is the control center of the scanner and runs on the built in 64bit Linux PC, making an external computer obsolete. It is operated through an optional external touchscreen but can also be accessed by any web browser via the scanner's IP address. ScanWizard functionality includes:

- Automatic document width and position detection
- Crop and deskew operation even on long documents
- Virtual rescan to change scanning parameters on the fly without physically scanning again.
- Sending images to USB, SMB, FTP or in the network

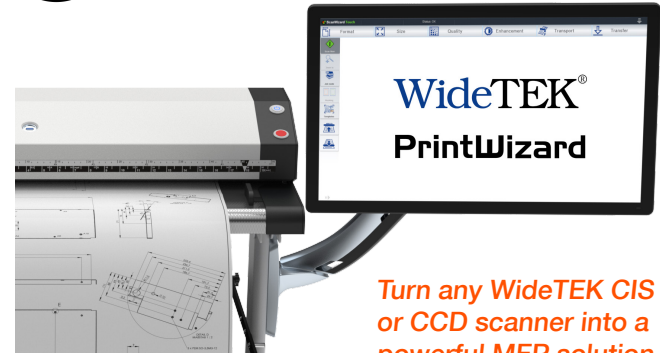

Turn any WideTEK CIS or CCD scanner into a powerful MFP solution

Ready to go MFP Bundles, direct access to:

- ✓ WideTEK® 36CL-MF1 for Canon TX series printers
- ✓ WideTEK® 36CL-MF2 for Canon TDS/LFP printers
- ✓ WideTEK® 36CL-MF3 for HP DesignJet and PageWide series printers
- ✓ WideTEK® 36CL-MF4 for Epson large format series printers
- ✓ WideTEK® 36CL-MF5 for Canon TM series printers

WideTEK® 36CL-MF1

For Canon TX Series Printers

The WideTEK® 36CL-600-MF1 mounts on top of a Canon TX3100/4100 or iPF 4100(S) wide format printer. Together with the integrated 64bit Linux-PC and the 21 inch touchscreen, the result is an economical MFP solution, featuring the fastest and best scanning capabilities in the industry.

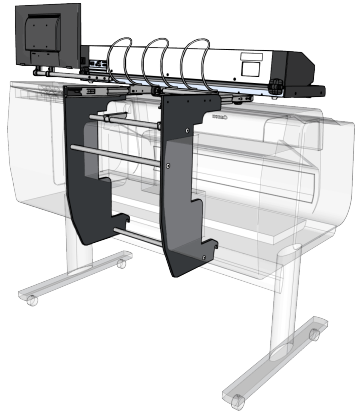

The WideTEK® 36CL-600-MF1 includes the Canon TX stand, which was developed specifically for the TX series printers, to give this MFP solution the smallest footprint possible. It also features a built-in closed loop color calibration function, producing the best possible copies for your selected printer and paper combination. Select media type, printing quality and more and watch the ink levels via printer integrated functionality in ScanWizard. All required software option keys are factory installed, making this the simplest MFP solution to implement.

WideTEK® 36CL-MF5

For Canon TM Series Printers

The WideTEK® 36CL-600-MF5 mounts on top of a Canon TM 300/305 series printer. Together with the integrated 64bit Linux-PC and the 21 inch touchscreen, the result is an economical MFP solution, featuring the best in industry scanning capabilities.



The WideTEK® 36CL-600-MF5 includes the Canon TM mounting brackets for the TM series printers, to give this MFP solution the smallest footprint possible. Unlike the standard MFP solution from Canon, this scanner is not limited. It scans with or without the printer and sends images to SMB, FTP, network or even other printers. The WideTEK® 36CL-600-MF5 solution also features a built-in closed loop color calibration function, producing the best possible copies for your selected printer and paper combination.

WideTEK® 36CL-MF2,3,4

WideTEK® 36CL-600-MF2 for
Canon TDS/LFP Printers

WideTEK® 36CL-600-MF3 for
HP DesignJet and PageWide Printers

WideTEK® 36CL-600-MF4 for
Epson Large Format Printers

WideTEK® 36CL-600-MF2 is a free standing scanner that scans, copies and archives documents at high speed together with all Canon wide format printers. The WideTEK® 36CL-600-MF2 features a built-in closed loop color calibration function, producing the best possible copies for your selected printer and paper combination. Together with the integrated 64bit Linux PC and the 21 inch touchscreen, the result is an economical MFP solution, featuring the best in industry scanning capabilities.

If you are planning an MFP solution with an HP DesignJet or PageWide series printer, or you want to replace an old scanner in your existing MFP system, the WideTEK® 36CL-600-MF3 is by far the fastest color CIS scanner on the market, running at 10 inches per second at 200 dpi in full color, like all of the WideTEK® 36CL-600-MF solutions. It also features the 21 inch touchscreen and an integrated 64bit Linux PC.

Build an MFP system with any Epson large format series printer to scan, copy and archive with the WideTEK® 36CL-600-MF4, also built on the fastest color CIS scanner on the market, running at 10 inches per second at 200 dpi in full color. All WideTEK 36CL-MF solutions feature the 21 inch touchscreen and an integrated 64bit Linux PC as well as a built-in closed loop color calibration function, producing the best possible copies for your selected printer and paper combination.



WideTEK® Adjustable Stand

The new WideTEK® stand, WT-STAND-ADJ is a fully adjustable stand that accepts printers of any width and up to 1180mm (46,5") high. The height of the stand can be lowered to 880mm (34,5"). It supports the WideTEK® 36CL and WideTEK® 48CL scanners, which when mounted to the stand, can be moved toward the front on telescopic guides. The design is not only very stable but also can invisibly hold the power supply, a network switch and a power extension bar in the back of the lower crossbar.

- ✓ Most versatile MFP stand in the industry
- ✓ Any width printer, up to 1180mm (46,5") high
- ✓ Fast copy to HP, Canon, Epson and Océ printers
- ✓ Sits against a wall, leveled via adjustable feet
- ✓ Slightly angled forward for convenient access by operators



Introducing Bookeye[®] 5

The next generation of the Bookeye[®] family of overhead book scanners

Full featured, production book scanners in three flexible models and two sizes

Fully reengineered, the Bookeye 5 family is a new generation of eco-friendly, ergonomic and easy to operate book scanners. Bookeye 5 book scanners are true scanner solutions, not just a digicam mounted on an expensive frame. Specifically designed for fast scanning and intuitive operation, all Bookeye 5 book scanners deliver professional image results.

Live Preview function uses a second matrix camera to present a live video view of the document position before scanning.

Dark mode operation, new to the Bookeye 5 book scanner, enhances scan quality through less light reflection and improves operation by reducing eye strain.

Multilingual operation, with over 20 languages available for the unique Scan2Net and ScanWizard user interfaces. Customize the interfaces to comply with corporate identity norms and standards.

Laser-assisted book fold correction effectively reduces annoying shadows and distortions in the middle of a scanned image of a book when operators are scanning thick bound documents, resulting in a perfectly flat scanned image.



Bookeye[®] 5 V3



Bookeye[®] 5 V2

Packed with Features and Functionality

Bookeye® 5

The Bookeye® 5 book scanner is so small that it can be set up on any desktop or workspace. Installation is simple, you will be scanning within minutes after taking it out of the box. Running on the latest Scan2Net® firmware, the Bookeye 5 family is packed with so many new features and functions, you will want to see them all for yourself.

The unique magnetically coupled book cradle solution allows users to digitize books and documents by either laying them flat on the scanning bed or in the V cradle, at an angle of 120°. The two sides of the cradle are magnetically coupled so that the book fold can be moved easily in the center for optimal scan results.

A 21 inch full HD multitouch screen allows the operator to control image quality and make many modifications on the fly. Pinch and swipe on the touchscreen the same way you would on a smartphone to zoom or move around in the image during preview.



There are three possible positions to attach the touchscreen: on the scanner neck, on the side of the scanner closer to the front or on the side of the scanner closer to the back, where you can angle the monitor in various degrees. It can also be used unattached, lying flat next to the scanner. Optionally a separate preview screen can be mounted to the neck, if the main touch is on the side.

OCR option**	1099	1099	1099
Scan2Pad®	1099	✓	1099
Foot Switch	1099	✓	✓
Full Coverage Warranty Basic + Kiosk	1099	✓	✗
Full Coverage Warranty Professional	✗	✗	✗
✓	included at no extra cost		
1099	optional, order separately		
✗	not available for this model		



- ✓ Easy three button operation: Start -- Scan -- Send
- ✓ V-shaped magnetically coupled book cradles, scan in flat or V mode 120 - 180 degrees
- ✓ Large 21" full HD multitouch screen, 2nd preview screen optional
- ✓ Operation in dark mode enhances scan quality and improves operation through less light reflection
- ✓ Live preview function shows the document position in live video for optimal placement
- ✓ Laser assisted book fold correction, scan bound documents without annoying shadows
- ✓ Automatic finger & thumb removal, auto crop & deskew
- ✓ Easy installation via Scan2Net® technology

Three Models Available

Bookeye® 5



Basic	Kiosk	Professional
400 x 400 dpi	400 x 400 dpi	600 x 600 dpi
Optional	Full coverage warranty 1 year	Full coverage warranty 1 year
DIN A2+ scan area (V2) DIN A3+ scan area (V3)	DIN A2+ scan area (V2) DIN A3+ scan area (V3)	DIN A2+ scan area (V2) DIN A3+ scan area (V3)
Flat and V cradles	Flat and V cradles	Flat and V cradles
21" full HD multitouch screen	21" full HD multitouch screen	21" full HD multitouch screen
Live preview mode	Live preview mode	Live preview mode
Laser-assisted book fold correction	Laser-assisted book fold correction	Laser-assisted book fold correction
Dark mode operation	Dark mode operation	Dark mode operation
Optional	Foot switch	Foot switch
Optional	Scan2Pad, WiFi Hot-spot	Optional
Optional	Optional	Client interface

Depending on your application needs, select the Bookeye® 5 Basic, Kiosk or Professional model. If your requirements become more demanding over time, you can upgrade to the next level model easily, protecting your initial investment while being flexible enough for growth.

Basic

The Bookeye 5 Basic model is the entry level model. It offers the same scanning functionality and speed as the other levels at the lowest possible cost.

Kiosk

The Bookeye 5 Kiosk model includes all of the features of the Basic model plus the Scan2Pad application for scanning and operation with any mobile device, a foot switch and the Image Access Full Coverage Warranty for one year. Up to five years of Full Coverage Warranty are optionally available on all models.

Professional

The Bookeye 5 Professional model includes all of the features of the Basic model, but has a higher resolution of 600 dpi and client interface for 3rd party software, to meet the highest quality standards. It also includes a foot switch and the Full Coverage Warranty for one year.

Bookeye® 5 V3



- ✓ Color book scanner for formats up to A3+, easily upgradable to 600 dpi professional version
- ✓ V-shaped magnetically coupled book cradle 120 - 180 degrees
- ✓ Book fold correction, automatic finger & thumb removal, auto crop & deskew and anti-reflection mode
- ✓ Large 21" full HD multitouch screen, 2nd preview screen optional
- ✓ Fulfills all criteria of the FADGI *** and Metamorfoze Light guidelines and ISO 19264-1 level B
- ✓ Scan Wizard for intuitive self service. Output to FTP, mail, SMB drives, USB 3.0 port
- ✓ Scan2Pad/Scan2Mobile—Wireless operation & storage (optional)
- ✓ Operation in dark mode, 20 languages supported
- ✓ Digital color balance, integrated ICC profile
- ✓ Easy installation via Scan2Net® technology

Fully reengineered, the Bookeye® 5 V3 is the smallest of a new generation of eco-friendly, easy to operate book scanners. Available in either the Basic or Kiosk models, Bookeye 5 V3 is a true scanner solution, not just a digicam on an expensive frame. Specifically designed as a self-service book scanner for formats 50 % larger than A3 (390 x 480mm / 15.3 x 18.9 inch), it delivers professional image results. The Bookeye 5 V3 book scanner is fast and easy to operate, affordable, but with the power of a production book scanner.

Scanner Optics	CCD camera, scans in color, grayscale, B&W
Resolution	400 x 400 dpi scanner resolution 600 x 600 dpi scanner resolution (optional)
Document Size	390 x 480 mm (15.3 x 18.9 inches)
Fastest Speed	A3+ @ 150 dpi: 0.8 seconds
Color Depth	48 bit color, 16 bit grayscale
Scan Output	24 bit color, 8 bit grayscale, bitonal, enhanced half-tone
Output Formats	Multipage PDF (PDF/A) and TIFF, JPEG, JPEG 2000, PNM, PNG, BMP, TIFF (Raw, G3, G4, LZW, JPEG), AutoCAD DWF, JBIG, DjVu, DICOM, PCX, Postscript, EPS, Raw data
Size H x W x D & Weight	720 x 510 x 540 mm (28 x 20 x 21 inches) 29 kg (64 lbs.)
Quality (min.)	ISO 19264-1 level B, FADGI ***, Metamorfoze Light
Power Consumption	< 0.5 W (Sleep) / 1.5 W (Standby) / 40 W (Ready to scan) / 110 W (Scanning)

Bookeye® 5 V2

The Bookeye® 5 V2 book scanner now scans faster and delivers the highest quality image results, while offering smart, new functionality. It is a true scanner solution, not just a digicam mounted on an expensive frame. Bookeye 5 V2 was specifically designed as a self-service book scanner for formats 14 % larger than A2 (460 x 620mm or 18 x 24 inch), intuitive built in operating system. Its modular product concept enables an easy upgrade from the Basic model to the Kiosk version or to the Professional version, depending on your budget and scanning requirements.

Scanner Optics	CCD camera, scans in color, grayscale, B&W
Resolution	400 x 400 dpi scanner resolution 600 x 600 dpi scanner resolution (optional)
Document Size	460 x 620 mm (18 x 24 inches)
Fastest Speed	A2+ @ 150 dpi: 0.9 seconds
Color Depth	48 bit color, 16 bit grayscale
Scan output	24 bit color, 8 bit grayscale, bitonal, enhanced half-tone
Output Formats	Multipage PDF (PDF/A) and TIFF, JPEG, JPEG 2000, PNM, PNG, BMP, TIFF (Raw, G3, G4, LZW, JPEG), AutoCAD DWF, JBIG, DjVu, DICOM, PCX, Postscript, EPS, Raw data
Size H x W x D & Weight	720 x 655 x 645 mm (28 x 26 x 25 inches) 33 kg (73 lbs.)
Quality (min.)	ISO 19264-1 level B, FADGI ***, Metamorfoze Light
Power Consumption	< 0.5 W (Sleep) / 1.5 W (Standby) / 40 W (Ready to Scan) / 110 W (Scanning)



- ✓ Color book scanner for formats up to A2+, easily upgradable to 600 dpi professional version
- ✓ V-shaped magnetically coupled book cradle 120 - 180 degrees
- ✓ Bookfold correction, automatic finger & thumb removal, auto crop & deskew and anti-reflection mode
- ✓ Large 21" full HD multitouch screen, 2nd preview screen optional
- ✓ Fulfills all criteria of the FADGI *** and Metamorfoze Light guidelines and ISO 19264-1 level B
- ✓ Scan Wizard for intuitive self service. Output to FTP, mail, SMB drives, two USB 3.0 ports
- ✓ Scan2Pad/Scan2Mobile—Wireless operation & storage (optional)
- ✓ Operation in dark mode, 20 languages supported
- ✓ Digital color balance, integrated ICC profile
- ✓ Easy installation via Scan2Net® technology

Introducing Bookeye[®] 5 Automatic

The next generation of the Bookeye[®] Automatic Book Scanners Automated High End Digitization with Motorized V-Shaped Glass Plate

Full featured, high speed automatic scanners in A2+ and A3+ sizes

Completely redesigned, the Bookeye 5 V3A and Bookeye 5 V2A offer unsurpassed image quality paired with simple operation, a modern design, and literally maintenance-free operation for all professional applications.

Scanning in 600dpi at 2.4 seconds for the entire A3+ or at 3 seconds for the A2+ capture area, it is equally suitable for large and small digitization projects.

Gentle document digitization paired with maximum productivity thanks to the motorized V-shaped glass plate

The new, motor-driven V-shaped glass plate ensures very gentle digitization of books, magazines, posters, folders, or bound documents of all kinds. Automatically moving at speeds from 19mm/sec up to 113mm/sec, it gently flattens originals using the V-shaped cradle.

Like all other Image Access Bookeye book scanners, the book cradle can also be used in flat mode.



Bookeye[®] 5 V3A



Bookeye[®] 5 V2A

Bookeye® 5 Automatic

The Bookeye® 5 V2A and V3A Automatic book scanners are full of features that make these scanners production workhorses. A 21 inch full HD multitouch screen allows the operator to control image quality and make many modifications on the fly. Pinch and swipe on the touchscreen the same way you would on a smartphone to zoom or move around in the image during the preview.

The Live Preview function uses a second matrix camera to present a live video view of the document position before scanning.

Dark mode operation, new to the Bookeye 5 family of book scanners, enhances scan quality through less light reflection and improves operation by reducing eye strain.



Scan2Net's extended user interface for controlling the V-shaped glass plate

Two Sizes Available

Bookeye® 5 V3A

Bookeye® 5 V2A

A3+ formats	A2+ formats
600 x 600 dpi in 2.4 seconds	600 x 600 dpi in 3 seconds
Maximum Document Size 390 x 480 mm (15.3 x 18.9 inches)	Maximum Document Size 460 x 620 mm (18 x 24 inch)
21 inch full HD 1920 * 1080 multi-touch screen	21 inch full HD 1920 * 1080 multi-touch screen
1 x USB 3.0 port, 4 x USB 2.0 port	2 x USB 3.0 port, 4 x USB 2.0 port
Dimensions HxWxD: 720 x 510 x 540 mm (28 x 20 x 21 inch)	Dimensions HxWxD: 720 x 655 x 645 mm (28 x 26 x 25 inch)
Weight: 31 kg (68 lbs.)	Weight: 37 kg (82 lbs.)
Magnetically coupled V-shaped book cradles 120 - 180 degrees	Magnetically coupled V-shaped book cradles 120 - 180 degrees
V-shaped glass plate controlled via ScanWizard's extended user interface	V-shaped glass plate controlled via ScanWizard's extended user interface
Live preview function for document positioning with live video	Live preview function for document positioning with live video
Laser-assisted book fold correction	Laser-assisted book fold correction
Dark mode operation	Dark mode operation
Full Coverage Warranty for 1 year	Full Coverage Warranty for 1 year
Optional foot switch for batch scanning	Optional foot switch for batch scanning

Bookeye® 5

V2 Semiautomatic



- ✓ Color overhead scanner for formats up to A2+, 600 x 600 dpi
- ✓ V shaped book cradle 120 - 180 degrees
- ✓ Motor driven V-shaped glass plate for perfect scans
- ✓ Open client interface for capturing software solutions
- ✓ Exceeds FADGI ** guidelines, ISO 19264-1
- ✓ Folder mode for scanning complete file folders
- ✓ Book fold correction, automatic finger & thumb removal, auto crop & deskew and anti-reflection mode
- ✓ Digital color balance, integrated ICC profile
- ✓ Easy installation via Scan2Net® technology

The Bookeye® 5 V2 Semiautomatic book scanner is suitable for digitization projects that require high quality and maximum productivity even in 24/7 operation. Originals up to A2+ in size such as books, magazines, posters, or bound documents of all types, can be digitized at high speed and at a maximum resolution of 600 dpi. The unique self-balancing V-shaped book cradle enables distortion free scans while protecting the book binding. A V-shaped glass plate ensures exact positioning on the book fold and if required, it can be removed without special tools or training.

Scanner Optics	CCD camera, scans in color, grayscale, B&W
Resolution	600 x 600 dpi scanner resolution
Document Size	460 x 620 mm (18 x 24.4 inches)
Fastest Speed	A2+ @ 150 dpi: 0.9 s
Color Depth	48 bit color, 16 bit grayscale
Scan output	24 bit color, 8 bit grayscale, bitonal, enhanced half-tone
Output Formats	Multipage PDF (PDF/A) and TIFF, JPEG, JPEG 2000, PNM, PNG, BMP, TIFF (Raw, G3, G4, LZW, JPEG), AutoCAD DWF, JBIG, DjVu, DICOM, PCX, Postscript, EPS, Raw data
Size H x W x D & Weight	900 x 880 x 860 mm (35.4 x 34.6 x 33.9 inches) 109 kg (240 lbs.)
Quality (min.)	ISO 19264-1 level B, exceeds FADGI **
Power Consumption	16.5 W (Standby) / 75 W (Ready to scan) / 150 W (Scanning)

Bookeye® 5 V1A Professional is the wide format scanner of choice for formats more than DIN A1+ up to 25x36". Using Image Access' cutting-edge camera technology, scan time is a mere 4 seconds at 600 dpi resolution, with all image enhancements turned on. The cycle time is less than 8 seconds, including all movements of the glass plate. Bookeye 5V1A's book cradle is the most versatile in the industry, supporting fully opened books at 180° with or without the glass plate as well as partially opened books via its V-shaped book cradle, all in one device. The book cradle plates can be separated to accommodate books with spines up to 20cm / 8" widths, supporting books weighing up to 30kg or 65lbs.



Scanner Optics	CCD camera, scans in color, grayscale, B&W
Resolution	600 x 600 dpi scanner resolution
Document Size	635 x 914 mm (25 x 36 inch), 16% more than DIN/ISO A1
Fastest Speed	A1+ @ 150 dpi: 1.2 seconds
Color Depth	48 bit color, 16 bit grayscale
Scan output	24 bit color, 8 bit grayscale, bitonal, enhanced half-tone
Output Formats	Multipage PDF (PDF/A) and TIFF, JPEG, JPEG 2000, PNM, PNG, BMP, TIFF (Raw, G3, G4, LZW, JPEG), AutoCAD DWF, JBIG, DjVu, DICOM, PCX, Postscript, EPS, Raw data
Size H x W x D & Weight	1160 x 900 x 900 mm (46 x 35 x 35 inches) 90 kg (198 lbs.)
Quality (min.)	ISO 19264-1 level B, FADGI *** Metamorfoze Light
Power Consumption	< 0.5 W (Sleep) / 1.5 W (Standby) / 120 W (Ready to scan) / 200 W (Scanning)

- ✓ Color book scanner for DIN/ISO A1+16%, 600 x 600 dpi
- ✓ 2 sec for A1+ scan @300 dpi, min. cycle time 5 sec
- ✓ 180° and V-shaped 140° scanning with/without glass plate, all in one device
- ✓ Book cradle supports books up to 30Kg/70lbs
- ✓ Motorized automatic glass plate can lift 20cm/8" and open to fully vertical
- ✓ AUTO mode triggers automatic scanning, effortless manual mode for scanning delicate objects
- ✓ Bookfold correction, automatic finger & thumb removal, auto crop & deskew and anti-reflection mode
- ✓ Digital color balance, integrated ICC profile
- ✓ Easy installation via Scan2Net® technology

Bookeye® 5

V1A-C35/C50



- ✓ Color book scanner for formats up to A1+, able to scan very thick books with a height of 350 mm (or 500 mm, optional)
- ✓ Gentle, protective V-shaped cradle 140 - 180 degrees
- ✓ 27" 4K display
- ✓ Glass plate for perfect scans, motorized for automatic or semiautomatic scanning
- ✓ Open client interface for capturing software solutions
- ✓ Scan2PDF - create PDF/A formatted output
- ✓ Bookfold correction, auto crop & deskew and anti-reflection mode
- ✓ Digital color balance, integrated ICC profile
- ✓ Easy installation via Scan2Net® technology

Bookeye® 5 V1A-C35/C50 is the professional solution for digitization projects that require high quality images at maximum productivity, while eliminating the strenuous, repetitive tasks required of an operator to get the job done. Bookeye 5 V1A-C35/C50 scans original documents up to A1 in size, with the unique book cradle for books 350 mm thick (or optionally 500 mm). The motor-driven glass plate distinguishes three modes: fixed glass plate, without glass plate and with an adjustable opening angle. In Auto Mode, the scanning process is fully automatic.

Scanner Optics	CCD camera, scans in color, grayscale, B&W
Resolution	600 x 600 dpi scanner resolution
Document Size	635 x 850 mm (25.0 x 33.5 inch) > A1
Fastest Speed	A1 @ 150 dpi: 1.2 seconds
Color Depth	48 bit color, 16 bit grayscale
Scan output	24 bit color, 8 bit grayscale, bitonal, enhanced half-tone
Output Formats	Multipage PDF (PDF/A) and TIFF, JPEG, JPEG 2000, PNM, PNG, BMP, TIFF (Raw, G3, G4, LZW, JPEG), AutoCAD DWF, JBIG, DjVu, DICOM, PCX, Postscript, EPS, Raw data
Size H x W x D & Weight	Book cradle closed: 1700 x 1100 x 960 mm (67.0 x 43.3 x 37.8 inch) 140 kg (309 lbs.)
Quality (min.)	ISO 19264-1 level B, FADGI **
Power Consumption	< 33 W (Standby) / 90 W (Ready to Scan, monitor on) 130 W (Scanning) / < 230 W (Fully automatic scan cycle)

available for
iOS and Android™



- ✓ Quickly adjust the color depth, from black & white to grayscale or full color
- ✓ Simplified brightness controls
- ✓ Automatic page splitting
- ✓ Single step creation of scanned pages as JPEG and PDF files
- ✓ Print quality copies of scans wirelessly via AirPrint (with iOS & AirPrint enabled printer)
- ✓ Mail directly from the App
- ✓ Upload the PDF to your iBook* library (*for iOS)
- ✓ Synchronize scanned documents to the iCloud* (*for iOS)
- ✓ Offline processing of scan jobs

Mobile Scanning via Tablet Changes the Way You Work

The Scan2Pad® application allows Image Access scanners to be controlled and operated using an iPad or an Android tablet or a smartphone running Android version 3.2 or higher or an iPhone. Experience a new way to work with our book and large format scanners and see how simple it is to configure and operate them using our mobile application Scan2Pad®.

Scan2Pad® is available for the iPad free of charge in the iTunes Store. The Android version of Scan2Pad® is also available at no cost from the Google Play Store. Look for the App „Scan2Pad“ or simply search for Bookeye® or WideTEK®.

Scan2Pad® supports all book scanners and book copiers with the brand name Bookeye® as well as all WideTEK® wide format scanners. The latest generation of scanners such as the Bookeye® 5, the WideTEK® 36 or the flatbed scanner WideTEK® 25 can be addressed as separate wireless access points, making them ideal for use with multiple systems in the public domain.



The new plug-in, Scan2PS for Adobe® Photoshop®, exports and saves scanned images either as jpg or tiff files, directly into the application. This saves an enormous amount of time and guarantees a high document throughput. The high dpi resolution of the templates included with the plug-in ensures images in perfect quality and color fidelity.

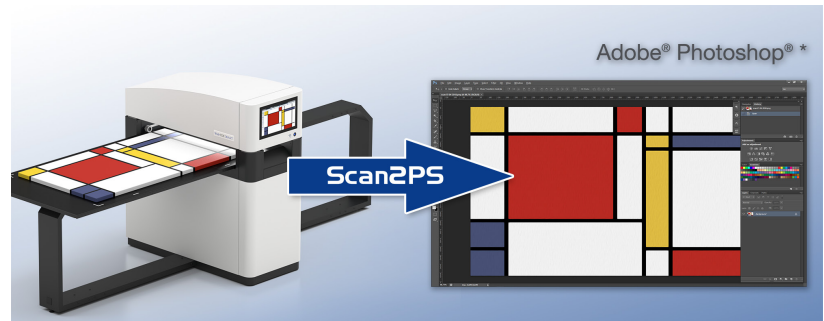
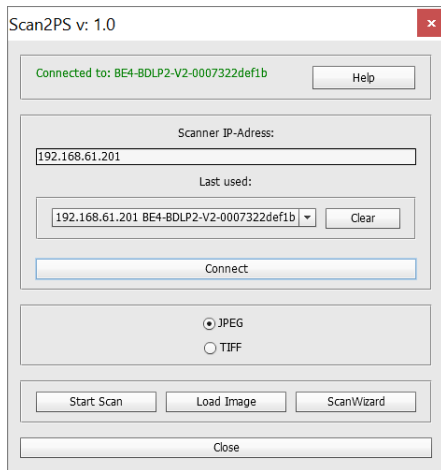

Scan2PS takes advantage of the extensive capabilities of Scan2Net® scanners; including automatic template size detection, color scanning, grayscale and black and white scanning.

The plug-in can be used on Adobe® Photoshop® software versions off CS6 and the Creative Cloud® and is available for customers to download free of charge in the Customer Service Portal. There you will also find a short installation instruction, which we recommend you read before installing.

*) Adobe product screenshot(s) reprinted with permission from Adobe Systems Incorporated. Adobe®, Photoshop® and Creative Cloud® are registered trademarks of Adobe Systems Incorporated, all other trademarks are the property of their respective owners.



BatchScanWizard

BatchScanWizard is a fast and easy to use software solution from Image Access for professional management of large scanning volumes and jobs. The software increases data throughput and reduces operational tasks substantially. BatchScanWizard is ideal for processing large volume scanning jobs but is just as useful for smaller volumes in which more advanced operations like page splitting or extracting specific areas on a document is required. A batch is started either using the foot switch or the user interface of the BatchScanWizard.

In addition to being able to set standard scan parameters such as brightness, contrast, color mode or file format; BatchScanWizard includes Scan Tool, for predefining regions in a document to extract, scan and save as separate images. A previously scanned document can be modified and the resulting image quality improved without having to rescan.

The operator can configure frequently used functions and operations on hotkeys and activate them with the single press of a key. Even complex operations can be configured for hotkeys.

BatchScanWizard is available for purchase and for download online in the Customer Service Portal.

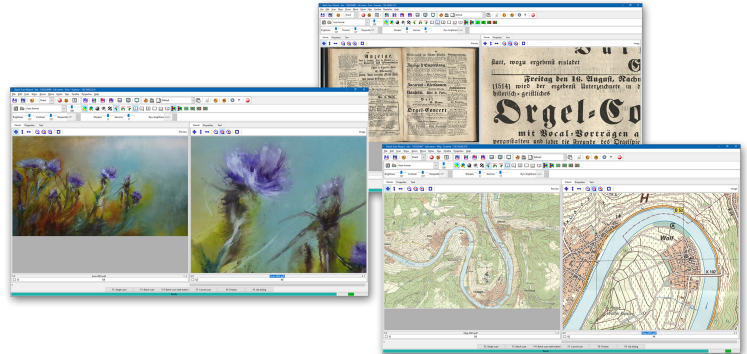

- ✓ Automated scanning of high volume source documents
- ✓ Easy configuration with templates
- ✓ Manage scan parameters in jobs
- ✓ On the fly modification of scanned images
- ✓ Hotkeys - frequently used operations at the press of a key
- ✓ Scan Tool - scan user definable sections of source documents
- ✓ Variable page splitting
- ✓ Time saving, high data throughput, perfect for production
- ✓ Purchase and download from Image Access Customer Service Portal



Scan2OCR is an optional software function which allows the user to scan in job mode and to OCR the entire page or multiple pages scanned, using multipage PDF mode. The OCR process runs in the background so that you can continue scanning subsequent pages in the job. This function is useful when scanning complete source material such as books, legal files and other multipage documents for which the operator wants all of the text OCREd.

Scan2OCR is based on the Tesseract OCR engine and the layout analysis software Leptonica. The Tesseract engine is considered one of the best OCR software engines available and currently supports more than 100 languages, including many from Asia.

The OCR engine runs in the background at a low priority level and uses all remaining computing power. The multitasking software will not slow down the scanning process. Many language packages can be downloaded for free from our portal and installed on the target scanner.

Scan2ICC is an online tool for creating and storing an individual ICC profile for a single Scan2Net® scanner. This service is a simple, cost efficient alternative to expensive, complicated third party software.

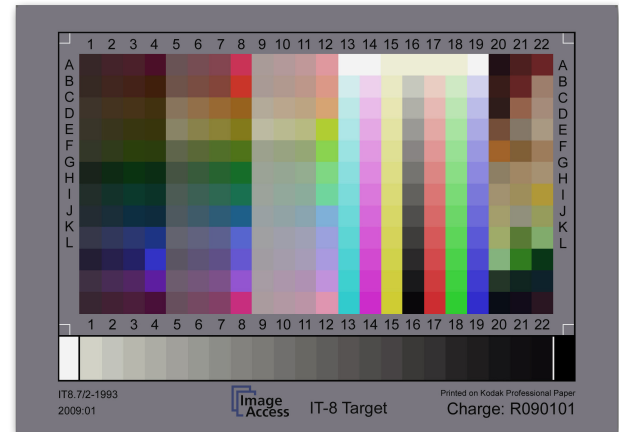

- ✓ Subscription for individual ICC profile for each Scan2Net® scanner
- ✓ True color output for copy applications
- ✓ Clear and simple operation
- ✓ Cost efficient subscription, available for purchase on the Customer Service Portal or ask for pricing

PerfectStitch

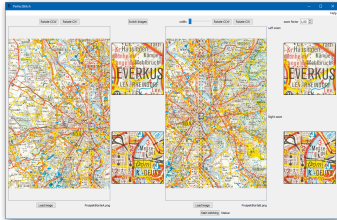

**The Easiest Way to
Make One Out of Two!**

**Download your trial version
from our homepage today!**

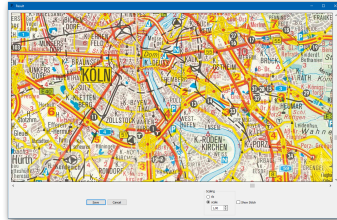

The PerfectStitch software add-on from Image Access is the easiest to use, most intuitive solution for fast and accurate stitching of two or more JPEG and TIFF images.

The high quality images generated by Image Access scanners can be stitched together perfectly in three simple steps. Double the scan area of your Image Access Scanner with PerfectStitch!

BCS-2[®]

BCS-2[®] is a solution for digitizing, post-processing and electronic publishing books, magazines and maps. BCS-2[®] can be used to control book scanners, flatbed, sheetfeed and microfilm scanners and copiers. The scan results of the job processes are seamlessly passed into workflow systems.

Applications

- Electronic document delivery: production of digitized material
- Internet / Intranet publication, access to e-mail systems
- Connection to CMS, DMS, archive and workflow systems

Order Management

- Integrated Order Management
- Management and export, and (re-) import of jobs
- Configurable profiles
- Editing, printing, and deleting jobs

- ✓ User defined formats, profiles for different styles, batch scanning of large volumes of documents and books
- ✓ Black border removal and deskew
- ✓ Automatic rotation after scanning - zoom, rotate, invert
- ✓ Thumbnails to view all scans in a scan job
- ✓ Format adaptation of different sizes on a target format template
- ✓ Flexible cropping, masking and page splitting
- ✓ MAPI interface for applications such as MS Outlook/Exchange, Lotus Notes, Mozilla Thunderbird, etc.
- ✓ Print jobs for single image, entire orders and printing and scanning in parallel



	INDIANA		OHIO		MICHIGAN		ILLINOIS
Fishers Indianapolis	Muncie	Ft. Wayne	Perrysburg Toledo	Novi Detroit	Champaign		
9901 Allisonville Road Fishers, IN 46038 (866) 884-4115	2810 N. Wheeling Ave. Muncie, IN 47303 (800) 884-4115	1239 N. Wells Street Ft. Wayne, IN 46808 (866) 782-4115	28304 Cedar Park Blvd., Suite D Perrysburg, OH 43551 (419) 661-9841	40000 Grand River Ave., Suite 112 Novi, MI 48375 (248) 707-1890	404 E University Ave. Champaign, IL 61820 (217) 359-3261		